

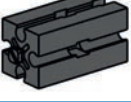























































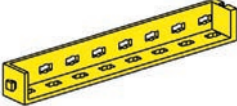
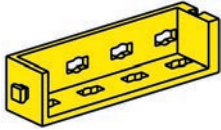





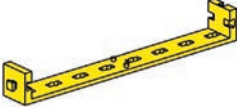



	32 879 116 251 136 528	Baustein 30 Building block 30 schwarz / black rot / red gelb / yellow
	32 880	Baustein 30 mit Bohrung Building block 30 with bore
	32 881 116 252 136 529	Baustein 15 Building block 15 schwarz / black rot / red gelb / yellow
	32 882	Baustein 15 mit 2 Zapfen Building block 15 with 2 pins
	31 010	Winkelstein 60° Angular block 60°
	31 011	Winkelstein 30° Angular block 30°
	31 981	Winkelstein 15° Angular block 15°
	32 071	Winkelstein 7,5° Angular block 7,5°
	37 237	Baustein 5 Building block 5
	37 238	Baustein 5 mit 2 Zapfen Building block 5 with 2 pins
	37 468	Baustein 7,5 Building block 7,5
	38 240	Baustein V15 Eck Building block V15 corner
	32 064	Baustein 15 mit Bohrung Building block 15 with bore
	38 423	Winkelstein 10x15x15 Angular block 10x15x15
	38 428	Bauplatte 15x30x5 mit 3 Nuten Building plate 15x30x5 with 3 grooves
	35 049	Baustein 15x30x5 mit Nut und Zapfen Building block 15x30x5 with groove and pin
	38 277	Bauplatte 15x45 mit 2x2 Zapfen Building plate 15x45 with 2x2 pins





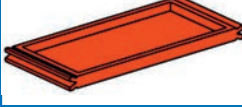

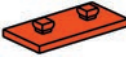

	31 918	Winkelstein 60° mit 3 Nuten Angular block 60° with 3 grooves
	32 330	Bauplatte 15x30x3,75 mit Nut Building plate 15x30x3,75 with groove
	31 426	Gelenkwürfel-Zunge Hinged block tab
	31 436	Gelenkwürfel-Klaue Hinged block claw
	36 819	Lagerhülse Axle sleeve
	31 060 31 061 31 330	Verbindungsstück Link 15 30 45
	31 982	Federnocken Spring cam
	36 323	S-Riegel 4 Single rivet 4
	36 324	S-Riegel 6 Single rivet 6
	37 232	Verschlussriegel Locking pin
	35 799	Riegelschlüssel Rivet holder
	36 334	Riegelscheibe Locking washer
	32 316	Verbindungsstopfen Connecting plug
	35 975	Statikadapter Statics adapter
	31 848	Strebenadapter Strut adapter
	31 667	Lasche 15 Connecting strip 15
	31 668	Lasche 21,2 Connecting strip 21,2

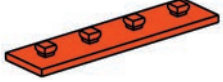
	31 671	L-Lasche L-shaped lug
	31 672	T-Lasche T-shaped lug
	31 675	Kreuzlasche Cross-shaped lug
	31 673	Sternlasche Star-shaped lug
	31 664	Doppelknotenplatte Double gusset plate
	31 674	Adapterlasche Adapter-girth
	31 670	Winkellasche Angle-girth
	38 253	Kupplungsstück Coupling
	38 260	Kupplungsstück 30 Coupling 30
	31 994	Schalthebel Gear lever
	38 544 31 764 36 328 36 322 32 200 31 765 36 335	I-Strebe gelb I-Strut yellow 15 30 45 60 75 90 120
	160 541 160 542 160 543 160 544	I-Strebe silber I-Strut silver 15 45 75 120
	36 914 36 924	I-Strebe schwarz I-Strut black 15 120

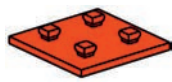
	38 542 36 326 35 058 35 059 36 336	X-Strebe gelb X-Strut yellow 42,4 63,6 84,8 106,0 169,6
	19 316 36 370 35 057 119 753	X-Strebe schwarz X-Strut black 42,4 63,6 106,0 169,6
	139 647 139 648	X-Strebe rot X-Strut red 106 169,6
	156 105 160 547 160548 137 654	X-Strebe silber X-Strut silver 42,4 63,6 106 169,6
	38 538 38 541 38 540 38 545 38 531 145 897 35 060	I-Strebe mit Loch, gelb I-Strut with bore, yellow 30 45 60 75 90 105 120
	36 912 36 913 36 952 36 923 38 543 38 546	I-Strebe mit Loch, schwarz I-Strut with bore, black 30 45 60 75 90 120
	160 545 160 546 153 668 153 669 153 670 153 367	I-Strebe mit Loch, silber I-Strut with bore, silver 30 45 75 90 105 120



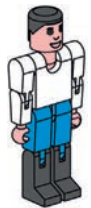





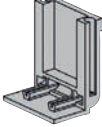
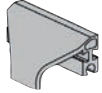

	146 529 143 235 146 531 146 532 156 502 143 236 159 781 146 533	15 30 45 60 75 90 105 120	I-Strebe mit Loch, grün I-Strut with bore, green
	139 646		I-Strebe mit Loch, rot 60 I-Strut red with bore, 60
	36 294 36 293 132 223		Winkelträger 120 Angle girder 120 gelb / yellow schwarz / black rot / red
	36 297 36 921 78 728		Winkelträger 60 Angle girder 60 gelb / yellow schwarz / black rot / red
	36 299 36 920 127 472		Winkelträger 30 Angle girder 30 gelb / yellow schwarz / black rot / red
	35 053 36 922 127 471		Winkelträger 15 Angle girder 15 gelb / yellow schwarz / black rot / red
	36 298 36 950 139 645		Winkelträger 15 mit 2 Zapfen Angle girder 15 with 2 pins gelb / yellow schwarz / black rot / red
	35 076 36 973		Statikstein Statics building block gelb / yellow rot / red
	32 850		Riegelstein 15x15 Building block 15x15
	35 054		Flachträger 120 Flat girder 120
	36 330		Bogenstück 30° Bow-shaped beam 30°

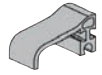
	35 055	Bogenstück 60° Bow-shaped beam 60°
	36 327	Flachstück 120 Beam 120
	35 052	Winkelträger 7,5° Angle girder 7,5°
	32 854 32 968 32 974	U-Träger 150 U-girder 150 schwarz / black rot / red gelb / yellow
	35 979	U-Träger Adapter U-girder adapter
	36 333	Laufschiene Rail
	31 221 31 226	Alu-Profil Aluminium strut 90 210
	31 013 36 341	Flachstein 30 Flatblock 30 rot / red blau / blue
	31 555	Flachstein 60 Flatblock 60
	36 593	Grundplatte 45x45 Base plate 45x45
	36 576	Grundplatte 90x45 Base plate 90x45
	35 129	Grundplatte 120x60 Base plate 120x60
	38 236 38 246 36 911	Bauplatte 15x15 Mounting plate 15x15 gelb / yellow rot / red schwarz / black
	38 241 38 268 156 504	Bauplatte 15x30 Mounting plate 15x30 rot / red gelb / yellow grün / green







	38 242 38 243 38 261 163 041	Bauplatte 15x45 Mounting plate 15x45 rot / red gelb / yellow schwarz / black grün / green
	38 464 38 474 133 008	Bauplatte 15x60 Mounting plate 15x60 rot / red gelb / yellow schwarz / black
	38 244	Bauplatte 15x75 Mounting plate 15x75
	38 245 38 486 156 106	Bauplatte 15x90 Mounting plate 15x90 rot / red gelb / yellow silber / silver
	38 259 146 534	Bauplatte 30x30 Mounting plate 30x30 rot / red grün / green
	38 248 163 042	Bauplatte 30x45 Mounting plate 30x45 rot / red grün / green
	38 249 38 432 152 249	Bauplatte 30x60 Mounting plate 30x60 rot / red gelb / yellow grün / green
	38 251 38 485	Bauplatte 30x90 Mounting plate 30x90 rot / red gelb / yellow
	32 853 35 806	Teilebeutel ft-Männchen Bag with figure blau / blue blau/weiß / blue/white
	32 321	Baustein 15 mit Ansenkung Building block 15 with counterbore
	19 318	Achse 55 schwarz mit Vierkant Axle 55 black with square

	78 237	Achse 50 rot mit Vierkant Axle 50 red with square
	31 124	Aufnahmeachse Holding axle
	36 586	Radachse Wheel axle
	38 317 35 405	V-Achse 4x51 rot / red 4x80 schwarz / black
	36 574 36 581 34 994 146 535 154 452	Rad 23 Wheel 23 schwarz / black rot / red weiß / white silber / silver grün / green
	34 995	Reifen 32,5 Tyre 32,5
	142 252 143 231 159 782	Felge 20,5x12 Wheel rim 20,5x12 gelb / yellow rot / red grün / green
	142 251	Reifen 35x15 Tyre 35x15
	142 253 144 446	Führerhaus 50x50x45 Cap 50x50x45 gelb / yellow grün / green
	142 297	Kippmulde 90x50, grün Dump body 90x50, green
	32 228	Achsschenkel Steering knuckle
	32 229	Spurstange R 30 Tie rods R 30



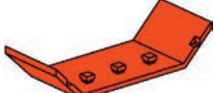







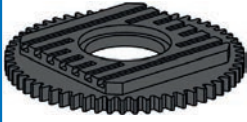
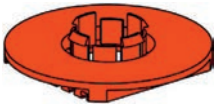

	32 230	Lenkradhalter R 30 Steering wheel holder R 30
	31 978	Sitzbaustein Seat building block
	35 998	Lenkklaue Steering claw
	31 843	Lenkwürfel Steering block
	31 894	Anlenkhebel Wrist pin
	38 473	Lenkhebel Steering lever
	31 614	Spurstange Track rod
	31 888	Gelenkstück Articulated piece
	35 068	Spurstangengelenk Track rod hinged
	32 852	Lenkstock Steering column base
	32 851	Lenksäule 34 Steering column 34
	35 067	Lenksäule 65 Steering column 65
	31 916	Lenkrad Steering wheel
	38 472	Zahnspurstange Cogged track rod
	32 859 32 860 32 861 163 433	Bodenplatte 30x90 Bottom plate 30x90 rot / red blau / blue gelb / yellow silber / silver
	163 434	Muldenklappe silber Trailer flap silver











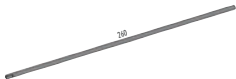

	163 435	Muldenseitenteil silber Trailer side section silver
	163 436 163 198	Seitenteil links Left side panel silber / silver grün / green
	163 437 163 199	Seitenteil rechts Right side panel silber / silver grün / green
	163 438 163 200	Verlängerung Seitenteil Extension side silber / silver grün / green
	163 201	Baustein 15x15 rund, rot Round building block 15x15, red
	163 202 163 439	Baustein 15x30 rund Round building block 15x30 grün / green rot / red
	163 519 163 518	Schlauch LD-PE 6x4 schwarz Hose LD-PE 6x4 black 50 mm 110mm
	163 203	Schlauchadapter D4 abgewinkelt Hose connection D4 angled
	163 204	Schlauchadapter D4 gerade Straight hose connection D4
	31 766 35 051	Sitz Seat schwarz / black blau / blue
	31 984	Schalensitz Bucket seat











	32 870	Clipsachse Axle with clip
	35 414	V-Achse 4x98 V-Axle 4x98
	106 766	Traktorreifen 80 Tractor tyre 80
	122 646	Rastfelge 43 Clip wheel rim 43
	146 245	Felge 43 Wheel rim 43
	32 913	Reifen 50 Tyre 50
	106767	Traktorreifen 50 Tractor tyre 50
	121 661	Traktorreifen 60 Tractor tyre 60
	32 627 32 883 78 727 116 913	Felge 30 Wheel rim 30 gelb / yellow rot / red weiß / white silber / silver
	163 605	Radkappe für Felge 30 Wheel cap for rim 30





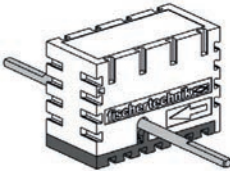
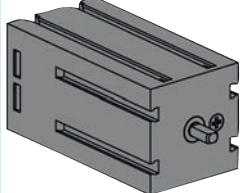
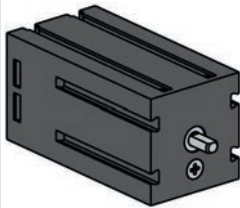

	163 205	Felge 40 Wheel rim 40
	163 206	Reifen 65 Tyre 65
	31 913 35 033	Nabenmutter Hub nut gelb / yellow rot / red
	146 985	Raupeband 139x34 Track band 139x34
	146 986	Förderband 290x49 Convoyer 290x49
	145634	Raupeband 79,5x17,5 Track band 79,5x17,5
	31 896	Kofflügel mit Zapfen Mudguard with pins
	35 050	Kofflügel Mudguard
	31 263	Aufliiegerkupplung Unterteil Trailer coupling, bottom part
	31 264	Aufliiegerkupplung Oberteil Trailer coupling, upper part
	38 446	Gelenkklaue Articulated jaw for trailer coupling
	35 115	Getriebewürfel Gear cube

	31 892	Kunststoff-Feder 26 Plastic spring 26
	31 891	Federboden schwarz Spring base plate
	31 997	Seilwindengestell Cable winch frame
	31 998	Seilwindentrommel Cable winch drum
	31 999	Seilwindenbremse Cable winch brake
	31 016	Seiltrommel Winch drum
	31 020	Klemmring für Seiltrommel Clamping ring for rope drum
	37 636	Rollenlager Roller bearing
	35 797	Seilrolle d=21 Rope pulley d=21
	38 258	Seilrolle d=12 Rope pulley d=12
	31 690	Rastachse 20 Clip axle 20
	32 085	Rollenbock Roller block
	35 668	Radhalter Wheel support
	36 573	Rad 14 Wheel 14

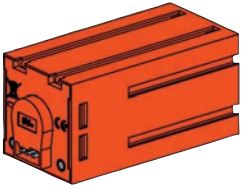
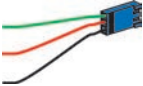
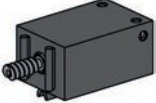
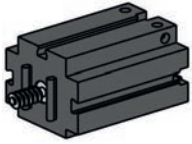
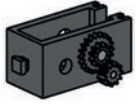

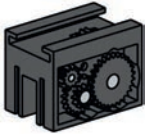





	31 390	Drehkranz-Oberteil Turntable top
	31 391	Drehkranz-Unterteil Turntable case
	35 039 32 869 31 027 127 514 32 846	Seil Cable 600 mm 1200 mm 2000 mm 3500 mm 6000 mm
	38 225	Seilhaken Hook
	31 597	Abstandsring Spacer ring
	31 983	Hülse 15 Sleeve 15
	37 679	Klemmbuchse 5 Clip 5
	31 023	Klemmbuchse 10 Clip 10
	31 058	Nabennutter mit Scheibe Hub nut
	35 031	Flachnabenzange Flat hub collet
	68 535	Freilaufnabe schwarz Freewheel hub black
	31 018	Reifen 45 Tyre 45
	31 019	Drehscheibe 60 Large pulley 60





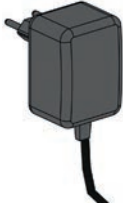
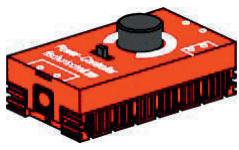

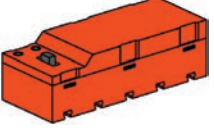



	38 413 38 414 38 415 38 416	Kunststoffachse Plastic axle 30 40 50 60
	31 034 31 033 31 032 37 384 31 040 31 031 31 036 31 030 35 696 35 697 159 590 107 436 160357	Metallachse Metal axle 30 50 60 80 90 110 125 150 170 200 235 260 450
	159 576	Metallachse 260 mit Abflachung Metal axle 260 with flattening
	35 112	Ritzel Z10, M1,5 Cog wheel T10, M1,5
	35 113	Spannzange Collet chuck
	31 915	Zangenmutter Hub nut
	31 054 31 053	Zahnstange M1,5 Rack M1,5 30 60
	35 694	Innenzahnrad Z30 Inter-toothed gear T30
	35 695	Zahnrad Z15 Gear wheel T15
	31 021	Zahnrad Z20 Gear wheel T20
	36 264	Zahnrad Z30 Gear wheel T30
	31 022	Zahnrad Z40/32 Gear wheel T40/32



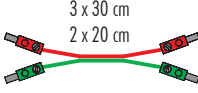
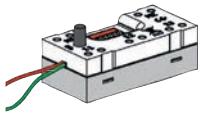
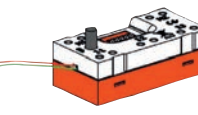







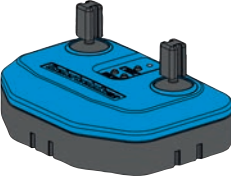

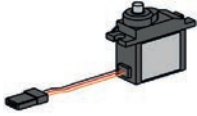
	31 779	Kettenrad Z20 Chain wheel T20
	37 858	Klemmbare Schnecke m=1,5 Locking worm m=1,5
	37 926	Schneckeenteil m=1,5 Worm m=1,5
	37 925	Schneckenmutter m=1,5 Worm nut m=1,5
	35 466	Nockenscheibe schwarz Cam plate black
	31 762 31 790	Rauprauenbelag Track link hart / hard weich / soft
	128 659	Rastkettenglied 13,5 schwarz Chain link 13,5 black
	36 248	Rastkettenglied 11,5 rot Chain link 11,5 red
	122 267	Rückzugsmotor Pullback motor
	151 178	Trackormotor 9V ~ Tractor motor 9V ~
	135 485	Motor XM 9V ~
	137 196	Differentialrad Motor XM Differential gear for Motor XM

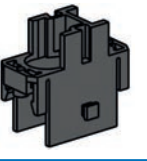









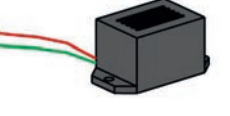
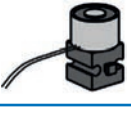

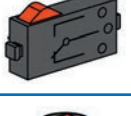
	153 422	Encodermotor 9V ...
	137 125	Encoderkabel 3adrig Encoder cable 3wire
	137 096	Motor XS 9V ...
	32 293	Mini Motor 6-9V ...; 0,65 A max.
	31 078	U-Getriebe Motor reducing gearbox
	31 063	U-Achse 60 mit Zahnrad Z28 Mini mot axle 60 with gear wheel T28
	31 082	Rastachse mit Zahnrad Z28, m=0,5 Clip axle with gear wheel T28, m=0,5
	37 272	Zahnstangengetriebe m=0,5 Motor rack gearbox
	37 457 37 351	Zahnstange m=0,5 Zahnstange m=0,5 30 60
	35 088	Gelenkkurbel Crank shaft
	35 063 35 064 35 065 35 087 35 066 37 527	Rastachse Clip axle 30 45 60 75 90 180
	35 061	Rastachse mit Kegelzahnrad Wheel axle with bevel gear

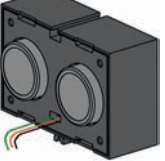
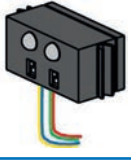
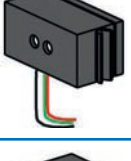
	35 062	Kegelzahnrad mit Hülse Bevel gear with sleeve
	36 227	Rastadapter Clip adapter
	35 073	Rastkupplung Axle coupling
	35 945	Rast-Ritzel Z10, m=1,5 Cog wheel T10, m=1,5
	137 677	Rastkettenrad Z20 Clip chain wheel T20
	37 157	Impulsrad 4 Impuls wheel 4
	35 072	Rastschnecke Worm
	35 069	Seilwinden-Gestell 30 Cable winch frame 30
	35 070	Seiltrommel für Rastachsen Cable winch drum
	35 971	Kardangabel für Rastachsen Cardan yoke for wheel axles
	35 972	Kardanwürfel Cardan cube
	136 775	Rastrolle Clip pulley
	35 977	Rastachse mit Schnecke m=1 Clip axle with worm m=1
	35 973	Schneckenmutter m=1 Worm nut M1,5
	130 593	Rastachse mit Platte Clip axle with Mounting plate









	31 411	Differential Käfig Z26 Differential gear, cage Z26
	31 414	Differential Antriebsrad Z14, m=1 Differential gear, driving wheel T14, m=1
	31 412	Differential Planetenrad Z10 Differential gear, planet wheel T10
	31 413	Differential Abtriebsrad Z10 Differential gear, driving wheel T10
	35 982	Deckel für Differential Käfig Cover for differential cage
	505 287	Schaltnetzgerät 9V ~~, 2,5A Switching power supply 9V ~~, 2,5A
	122 952	Schaltnetzteil 9V ~~, 2,3A USA Switching power supply 9V ~~, 2,3A USA
	139 778	Regler Power Set mit Festspannungsausgang Controller Power Set with fixed-voltage output
	522 460	Ladegerät 8,4V 700mA Charger 8,4V 700mA
	152 621	Wechselstecker HMP-UL (USA) Changeable plug hat HMP-UL (USA)
	152 622	Wechselstecker HMP-BS (UK) Changeable plug HMP-BS (UK)
	152 623	Wechselstecker HMP-AU (Aus) Changeable plug hat HMP-AU (Aus)
	35 537	Akkupack NiMH 8,4 V 1500 mA Rechargeable Battery Pack NiMH 8,4 V 1500 mA
	135 719	Batteriehälter (9V Block) Battery holder (9V)
	32 263	Batteriegehäuse für 9V-Block Battery holder (9V)
	32 958	Batteriegehäuse Deckel Cover for battery holder

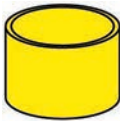
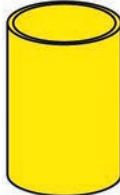

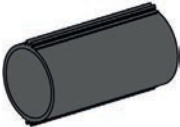
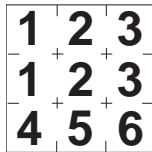
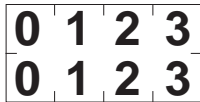



	31 337 31 336	Flachstecker montiert Flat plug rot / red grün / green
	36 443	Schraubendreher Screwdriver
	36 210 36 977 156 511 36 382 31 360 122 409 36 035	Litze 2-adrig rot/grün Lead red/green 250 mm 300 mm 500 mm 1000 mm 2000 mm 4000 mm 7000 mm
	35 608 152 949	Litze 1-adrig rot Lead red 300 mm 3000 mm
	147 009 152 948	Litze 1-adrig grün Lead green 300 mm 3500 mm
	147 264	Kabelbeutel mit 3x30 cm / 2x20 cm; Stecker montiert Bag with leads 3x30 cm / 2x20 cm; plugs assembled
	156 499	Roboticsmodul
	152 063	Electronicsmodul
	152 059	Elektronikgehäuse Electronic compartment
	152 218	Transistorplatine BC 547C PCB for transistor BC 547 C
	152 860	Transistor BC 547 C
	152 219	Kondensator 10µF 50V Capacitor 10µF 50V
	152 220	Widerstand 100 Ωk Resistor 100 Ωk
	152 222	Widerstand 10 Ωk Resistor 10 Ωk



	130 589	Sound + Lights Module
	161 942	Sender BT Control Set Transmitter BT Control Set
	161 943	Empfänger BT Control Set Receiver BT Control Set
	132 292	Micro Servo 4,8 / 6V
	132 004	Servohebel Servo-lever
	132 290	Servohalter Servo holder
	122 900	Servolasche Servo lug
	35 077 35 078 35 079 35 084 35 085 35 086	Rastleuchtkappe Light cap blau / blue orange / orange rot / red grün / green gelb / yellow klarsichtig / transparent
	37 869	Kugelstecklampe 9V $\ddot{=}$; 0,1 A Bulb lamp 9V $\ddot{=}$; 0,1 A
	37 875	Linsenstecklampe 9V $\ddot{=}$; 0,15 A Lens tip lamp 9V $\ddot{=}$; 0,15 A
	38 216	Leuchtstein mit Steckfassung Plug in light holder
	162 134	LED weiß montiert; 9V $\ddot{=}$; 0,01 A LED white assembled; 9V $\ddot{=}$; 0,01 A
	162 135	Lichtschranken LED montiert; Light barriers LED 24V assembled, 9V $\ddot{=}$; 0,01 A
	162 136	Rainbow LED montiert; 9V $\ddot{=}$; 0,01 A Rainbow LED assembled; 9V $\ddot{=}$; 0,01 A

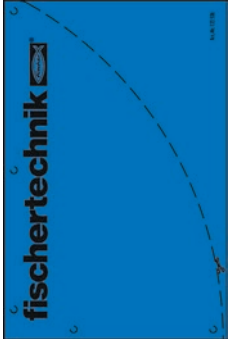

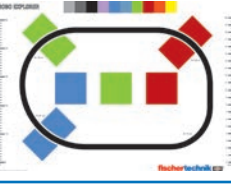
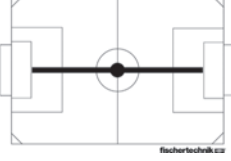
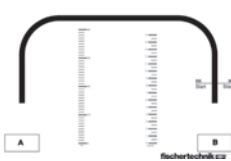
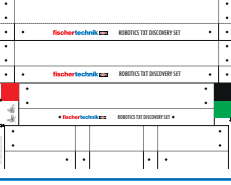
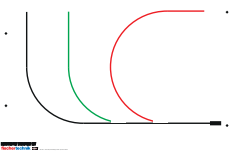



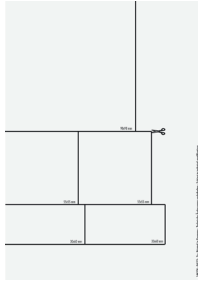

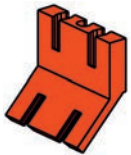

	152 522	USB Kamera USB Camera
	36 119	Summer Buzzer
	142 504	E-Magnet
	161 944	BT Smart Controller
	37 783	Mini-Taster Mini switch
	32 698	Foto-Widerstand Photo resistor
	133 009	Ultraschallsensor TX Ultrasonic Distance Sensor TX
	128 598	IR-Spursensor IR-Trail Sensor
	128 599	Farbsensor Optical Color Sensor
	36 708	Polwendeschalter Reversing switch
	36 134	Fototransistor montiert Photo transistor assembled
	36 532	Störlichtkappe, Öffnung 6 Masking light cap, hole 6,0
	36 437	NTC-Widerstand 1,5 k Ω NTC resistor 1,5 k Ω
	37 727	Schaltzscheibe Index cam
	36 120	Reedkontakt Reed contact
	35 969	Reedkontakt- und Kabelhalter Reed contact and cable clamp



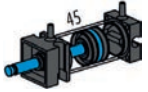
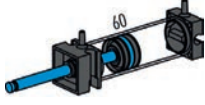
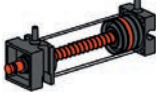









	108 278	Magnetbaustein Magnetic component
	119 850	Magnetischer Kugelhalter Magnetic ball holder
	144 262	Stahlkugel Steel ball
	36 147	Druckfeder 0,4x5x15 Pressure spring 0,4x5x15
	132 875	Druckfeder 0,3x5x45
	31 602	Kufe Skid
	31 771	Lagerstück 1 Bearing unit 1
	31 772	Lagerstück 2 Bearing unit 2
	35 980	Klemmhülse Clip
	107 356	Klemmstift d= 4,1 Clamping pin d=4,1
	107 355	Verbinder Connector
	35 981	Hülse mit Scheibe Sleeve with nut
	113 853	Greifzange kurz Gripper part
	31 592	Kesselhalter Sleeve holder
	36 132	Achskappe Hub cap

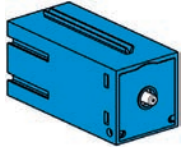





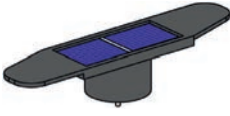

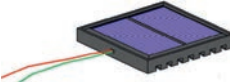
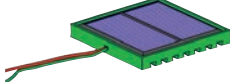
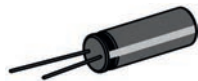

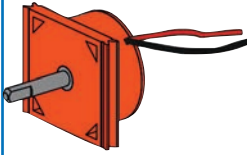
	35 409	Rohrhülse 30x20 Tubular sleeve 30x20
	35 389	Rohrhülse 30x43 Tubular sleeve 30x43
	31 707 36 703	Deckel Lid gelb schwarz
	36 702	Rohrhülse 30x60, schwarz Tubular sleeve 30x60, black
	143 389	Zahlenaufkleber Number stickers
	114 175	Zahlenaufkleber Number stickers
	154 454	Aufkleber TXT Discovery Set TXT Discovery Set sticker
	156 497	Aufkleber Mini Bots Mini Bots sticker
	152 657	Aufkleber Dynamic XL Dynamic XL sticker
	163 440	Aufkleber Trucks Trucks sticker
	151 369	Aufkleber Tractor Set IR Control Tractor Set IR Control sticker

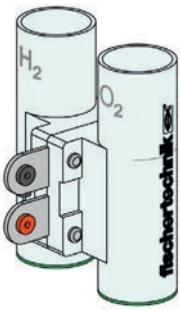

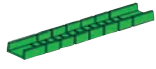
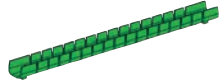

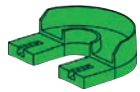
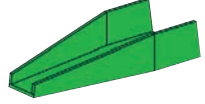

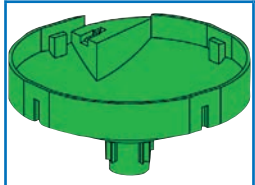



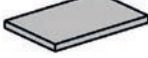

	123 539	Aufkleber Cars & Drives Cars & Drives sticker
	123 052	Aufkleber Pneumatic 3 Pneumatic 3 sticker
	123 536	Schnittvorlage Segel Sail
	137 357	Schnittvorlage Windrad Windmill
	128 962	Robo Explorer Parcours
	137 652	Parcours 1 ROBO TX Training Lab
	137 676	Parcours 2 ROBO TX Training Lab
	154 521	Bande Parcours ROBOTICS TXT Discovery Side board ROBOTICS TXT Discovery
	154 544	Parcours ROBOTICS TXT Discovery Side board ROBOTICS TXT Discovery
	156 498	Parcours Mini Bots A2







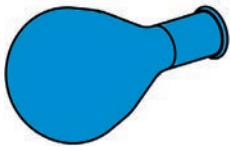



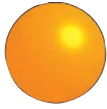
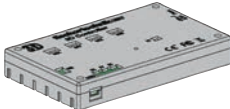

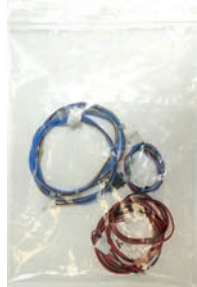
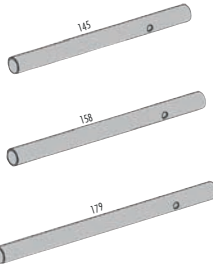



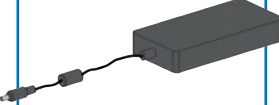



	146 376	Transparentpapier Optics Tracing paper Optics
	146 876	Schnittvorlage Optics Cut template Optics
	124 199	Gewindestift M8x50 Threaded pin M8x50
	33 582	Klebepunkt Self-adhesive disc
	36 010	Gummiring Rubber ring
	143 289	O-Ring 3x1
	35 678	O-Ring für Drehscheibe 31019 (54x3) O-Ring for Large Pulley 31019 (54x3)
	36 981	O - Ring 54 x 1,5 Silicon
	137 103	O - Ring 108
	122 649 156 104	Baggerlöffel Dredger bucket rot / red silber / silver
	36 925	Schaufel rot Shovel red



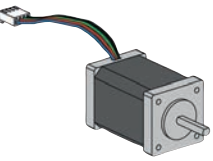
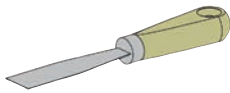

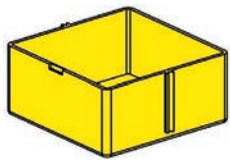

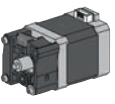

	38 411	Schaufelhalter Shovel support
	19 317	Speichenrad Spoke wheel
	36 337	Luftschraube mit 4 Flügeln 4-blade propeller
	36 559 156 108	Luftschraube 100 Propeller 100 blau / blue grün / green
	37 681	Adapterspitze für Luftschrauben Pointed adapter for propellers
	122 641	Pneumatik - Zylinder 45 Pneumatic cylinder 45
	36 938	Pneumatik - Zylinder 60 Pneumatic cylinder 60
	133 027	Zylinder 60 mit Feder Cylinder 60 with spring
	122 647	Zylinderrohr 44 m. Kopf Cylinder tube 44 with head
	31 637	Zylinderrohr 44 Cylinder tube 44
	36 934	Pneumatik - Handventil Pneumatic hand - valve
	156 107 122 363	Pneumatikschlauch Pneumatic hose 1200 mm 3000 mm
	133 028	Vakuumsauger Vacuum suction cup

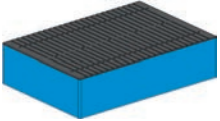
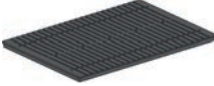
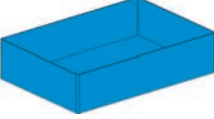

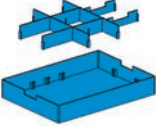

	36 915	Winkelanschluß Angle connector
	31 708	P - Stopfen P - plug
	31 642 156 042	T - Stück T - piece blau / blue schwarz / black
	31 632	Düse Nozzle
	31 422	Achsadapter Adapter
	121 470	Kompressor 9 V Compressor 9 V
	156 493	Druckluftspeicher Airtank
	121 640	Schlauchanschluss Kompressor Hose connection, Compressor
	35 328	Schlauchanschluss Magnetventil Hose connection, solenoid valve
	35 327	3/2-Wege Magnetventil 9-12V 3/2-way solenoid valve 9-12V
	37 034	Doppelklebestreifen 14x60 Double adhesive strip 14x60
	145 415	Solarrotor
	145 416	Adapter für Solarrotor Adapter for solarrotor
	146 142	Solar modul 1V 440 mA Solar module 1V 440 mA
	156 121	Solar modul 2V 200mA Solar module 2V 200mA
	37 031	Goldcap 10F/2,3V

	156 494	Solar-Micromotor 0,5-2V mit Gehäuse Solar-Micromotor 0,5-2V with housing
	68 451	LED 5mm grün/green L53GD/B
	146 500	Fuel Cell
	145 900	Fuel Cell Halter Fuel Cell holder
	143 234 121 641	Flexprofil 180 mm Flexible rail profile grün / green blau / blue
	155 901	Flexprofil 90 mm, grün Flexible rail profile 90mm, green
	159 783	Flexprofil 180 mm High Speed, grün Flexible rail profile High Speed, green
	151 715	90° Kurve, grün 90° curve, green
	158 962	180° Kurve, grün 180° curve, green
	151 716	Wechselweiche Unterteil, grün Cross-over lower part, green
	151 717	Wechselweiche Oberteil Cross-over lever
	155 902	Trichter Funnel
	145 860	Linse Bikonvex D=22,4; f=25 Lens biconvex D=22,4; f=25
	145 862	Linsenhalter Bikonvex Lens holder biconvex

	145 863	Linse Plankonvex D=27; f=80 Lens plano-convex D=27; f=80
	145 864	Linsenhalter Plankonvex Lens holder plano-convex
	146 373	Spiegelplatte 45x30x3 mm Reflecting plate 45x30x3 mm
	146 374	Styroporkugel D20 Styrofoam ball D20
	146 375	Styroporkugel D50 Styrofoam ball D50
	146 377	Lichtleiter D1; 2 m Fibre optics D1; 2 m
	133 200	Werkstück 26x14 rot Work piece 26x14 red
	133 201	Werkstück 26x14 weiß Work piece 26x14 white
	133 202	Werkstück 26x14 dunkelblau Work piece 26x14 dark blue
	160 551	Werkstückträger 29,5x29,5x17,5 Workpiece Carrier 29,5x29,5x17,5
	141 205	Hygrometerfaden Hygrometer cord
	122 648	ft-Luftballon ft-balloon
	122 950	Flechtgummikordel Rubber band

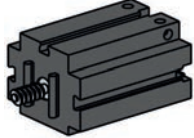
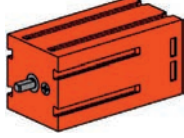
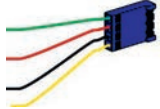
	154 485	TT-Ball orange D=38 mm Table Tennis Ball orange D=38 mm		160 670	3D-Controller
				160 540	Mikro-USB-Kabel Micro USB-cable
	155 903	Bootsrumpf Katamaran Boat hull Catamaran		160 841	Kabelbeutel 3D-Drucker Bag Cables 3D Printer
	156 130	Beutel Klangrohre Dynamic M Bag with tubular bells Dynamic M		161 252	Aufkleber „Hot Surface“ Sticker „Hot Surface“
	156 043	Silikonschlauch 450 mm transparent Silicon hose 450 mm transparent		161 253	Siliconfett Tube 6g Silicone grease tube 6g
				161 254	Netzteil 19V DC, 6,3A Power Supply 19V DC, 6,3 A
	159 577	Abtriebsritzel Schrittmotor Pinion stepper motor		161 255	Netz kabel Cable
	160 549	Abtriebshülse Schrittmotor Drive sleeve stepper motor		161 256 162 605 162 606	Eurostecker / Euro Plug US-Stecker / US Plug UK-Stecker / UK Plug AUS-Stecker / AUS Plug
	160 528	Schrittmotorhalter Holder stepper motor		161 257	Justierkarte Adjustment card 3D printer
	160 843	Zylinderschraube DIN84-M3x4 m. Schlitz Slotted cheese head screw DIN 84-M3x4		161 261	U-Scheibe M4 Washer 4mm ISO 7089
	160842	Schrittmotor Nema 14 Stepper motor Nema 14		161 837	Malerspachtel 25 mm Spatula 25mm
	160 550	Kunststoffplatte klar, 170x151x2 Plastic plate transparent 170x151x2		32 076 130 961	Kassette 60x60 Bottom of cassette 60x60 gelb / yellow rot / red
	160 838	Buildtrak 165x120		35 360	Kassetten-Deckel Cassette cover
	160 839	Extruder kompl. montiert Extruder compl. assembled			
	160 840	Hotend			

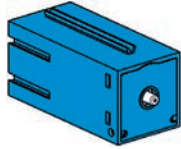
	30 383	Box 1000 bestehend aus / consisting of:
	35 602	Grundplatte 390x270 Base plate 390x270
1x 	36 497	Box 390x270
1x 	36 587	Sortierwanne 128x188 Innerbox 128x188
8x 	36 588	Zwischenwand Divider for innerbox
32x 		
	94 828	Aufbewahrungssystem bestehend aus / Storage system consisting of:
	36 360	Box 258x186
1x 	36 356	Zwischensteg für Box 500, lang Divider for Box 500, long
2x 	36 357	Zwischensteg für Box 500, kurz Divider for Box 500, short
	32 985	Grundplatte 258x186 Base plate 258x186

Sonderteile für Industrie- / Trainingsmodelle Special parts for training models		
	37 488	Mini Motor 24V ~; ; 0,3 A max.
	144 643	Encodermotor 24V ~
	119 785	Encoderkabel 4adrig Encodercable 4wire
	163 674	Lichtschranken LED 24V montiert Light barriers LED 24V assembled
	103 463	Werkstück Workpiece
	144 740	Kompressor 24V Compressor 24V
	77 622	3/2-Wege Magnetventil 24V 3/2-way solenoid valve 24V